

Reduzierhülsen

Reduction Sleeves



Reduzierhülsen mit Bund

Reduction Sleeves with Flange

Bild 1
picture 1



Bild 7
picture 7



Bild 2
picture 2

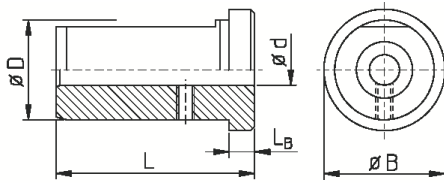

Bild 8
picture 8

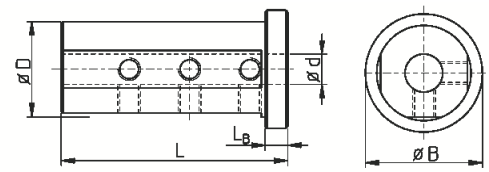

Bild 3
picture 3

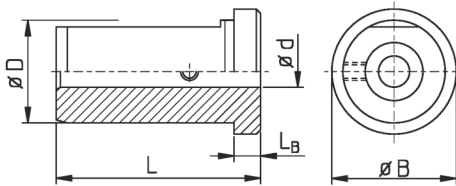

Bild 9
picture 9

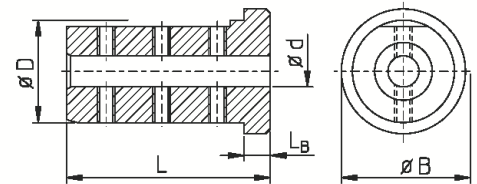

Bild 4
picture 4

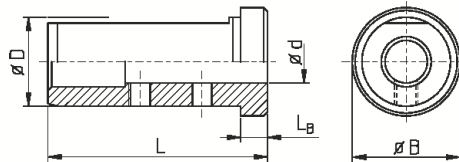

Bild 10
picture 10

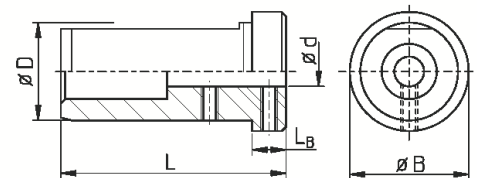

Bild 5
picture 5

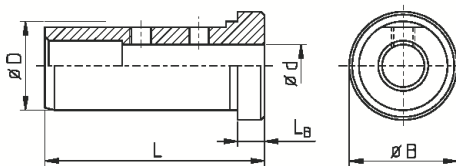

Bild 11
picture 11

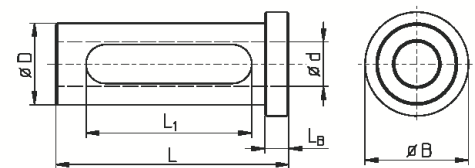

Bild 6
picture 6

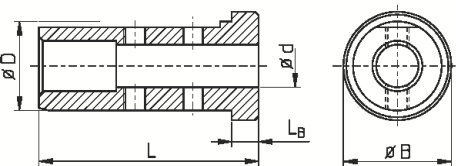

Bild 12
picture 12

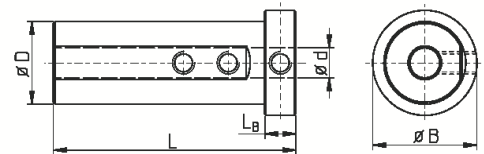

Zahl der Spannflächen und Gewindebohrungen kann von den Musterzeichnungen abweichen
Number of clamping flats and thread holes may vary from the shown drawings

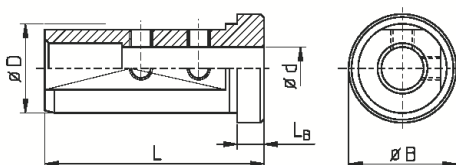
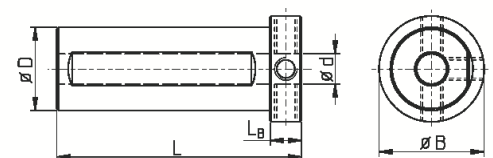

Bild 13
picture 13



Bild 17
picture 17



Bild 14
picture 14

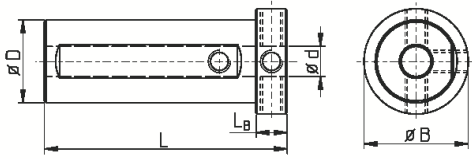

Bild 18
picture 18

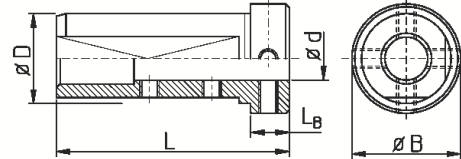

Bild 15
picture 15

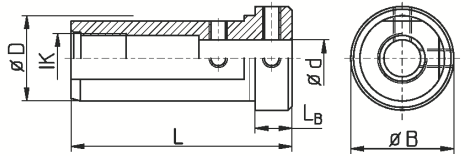

Bild 19
picture 19

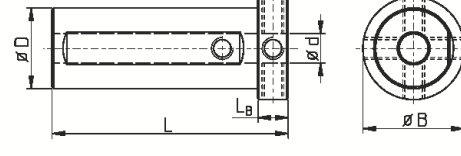

Bild 16
picture 16

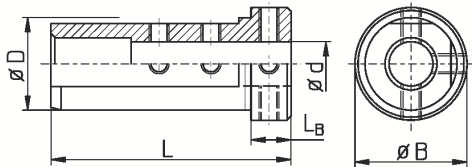

Bild 20
picture 20

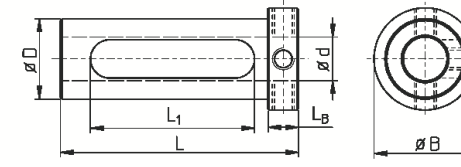

Bild 21
picture 21

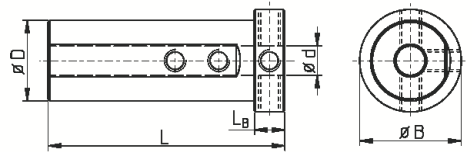

Zahl der Spannflächen und Gewindebohrungen kann von den Musterzeichnungen abweichen
Number of clamping flats and thread holes may vary from the shown drawings

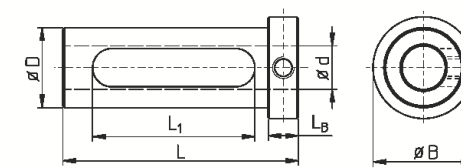
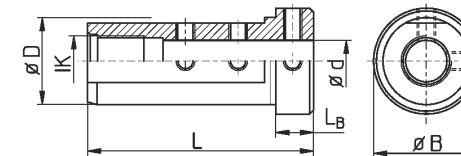

Artikel-Nr. article-no.	alte Art.-Nr. old art.-no.	D	d	L	L _B	L ₁	B	Bild pic
RB160442	RBST1604	16	4	42	2	--	20	8
RB160542	RBST1605	16	5	42	2	31	20	10
RB160642	RBST1606	16	6	42	2	31	20	10
RB160842	RBST1608	16	8	42	2	31	20	10
RB161042	RBST1610	16	10	42	2	31	20	10
RB161242	RBST1612	16	12	42	2	31	20	10
RB190460	RBST1904	3/4"	4	60	10	--	28	12
RB190560	RBST1905	3/4"	5	60	10	--	28	12
RB190660	RBST1906	3/4"	6	60	10	--	28	13
RB196360		3/4"	1/4"	60	8	40	28	19
RB197960		3/4"	5/16"	60	8	40	28	19
RB190860	RBST1908	3/4"	8	60	10	--	28	13
RB191060	RBST1910	3/4"	10	60	10	--	28	13
RB191260	RBST1912	3/4"	12	60	10	40	28	19
RB191360		3/4"	1/2"	60	10	40	28	19
RB191460	RBST1914	3/4"	14	60	10	40	28	19
* RB191560		3/4"	15	60	10	40	28	19
RB195860		3/4"	5/8"	60	10	40	28	19
RB191660	RBST1916	3/4"	16	60	10	40	28	19
RB200442	RBL2004	20	4	42	2	--	24	8
RB200460	RBST2004	20	4	60	10	--	28	18
RB204760		20	3/16"	60	10	--	28	18
RB200542	RBL2005	20	5	42	2	--	24	9
RB200560	RBST2005	20	5	60	10	--	28	18
RB205560	RBST20055	20	5,5	60	10	--	28	13
RB200635	RBK2006	20	6	35,5	2	--	24	1
RB200642	RBL2006	20	6	42	2	--	24	8
RB200644	RBSM2006	20	6	44	4	33,5	25	10
RB200660	RBST2006	20	6	60	10	--	28	13
RB206360		20	1/4"	60	10	--	28	13
RB200760	RBST2007	20	7	60	10	--	28	13
RB207960		20	5/16"	60	10	--	28	13
RB200835	RBK2008	20	8	35,5	2	--	24	1
RB200842	RBL2008	20	8	42	2	--	24	8
RB200844	RBSM2008	20	8	44	4	33,5	25	10
RB200860	RBST2008	20	8	60	10	--	28	13
RB209560		20	3/8"	60	10	--	28	12
RB201035	RBK2010	20	10	35,5	2	28	24	10
RB201042	RBL2010	20	10	42	2	32	24	10
RB201044	RBSM2010	20	10	44	4	33,5	25	10
RB201060	RBST2010	20	10	60	10	--	28	12
RB201235	RBK2012	20	12	35,5	2	28	24	10
RB201242	RBL2012	20	12	42	2	32	24	10
RB201244	RBSM2012	20	12	44	4	33,5	25	10
RB201255	RBSL2012	20	12	55	5	43	26	10
RB201260	RBST2012	20	12	60	10	--	28	12
RB201360		20	1/2"	60	10	--	28	12
RB201435	RBK2014	20	14	35,5	2	28	24	10
RB201442	RBL2014	20	14	42	2	32	24	10
RB201456	RBSL2014	20	14	56	6	43,5	26	10
RB201460	RBST2014	20	14	60	10	--	28	12
RB205860		20	5/8"	60	10	--	28	12
RB201635	RBK2016	20	16	35,5	2	28	24	10
RB201642	RBL2016	20	16	42	2	32	24	10
RB201644	RBSM2016	20	16	44	4	33,5	25	10
RB201656	RBSL2016	20	16	56	6	43,5	26	10
RB201660	RBST2016	20	16	60	10	--	28	12

* Ausverkaufsartikel

Artikel-Nr. article-no.	alte Art.-Nr. old art.-no.	D	d	L	L _B	L ₁	B	Bild pic
RB220465	RBST2204	22	4	65	8	--	28	18
RB220565	RBST2205	22	5	65	8	--	28	18
RB220665	RBST2206	22	6	65	8	--	28	13
RB220865	RBST2208	22	8	65	8	--	28	13
RB220865IK		22	8	65	8	--	28	14
RB221065IK	RBST2210	22	10	65	8	--	28	14
RB221265	RBST2212	22	12	65	8	45	28	19
RB221465	RBST2214	22	14	65	8	45	28	19
RB221665	RBST2216	22	16	65	8	45	28	19
RB250456	RBSL2504	25	4	56	6	42	31	10
RB250475	RBL2504	25	4	75	10	--	33	9
RB250575	RBL2505	25	5	75	10	--	33	9
RB250650	RBK2506	25	6	50	4	--	29	4
RB250660	RBST2506	25	6	60	6	--	31	7
RB250664	RBB2506	25	6	64	10	--	34	3
RB250675	RBL2506	25	6	75	10	--	34	9
RB250850	RBK2508	25	8	50	4	--	29	4
RB250856	RBSL2508	25	8	56	6	40	31	10
RB250857	RBA2508	25	8	57	2	--	29	2
RB250860	RBST2508	25	8	60	6	--	31	7
RB250864	RBB2508	25	8	64	10	--	34	3
RB250875	RBL2508	25	8	75	10	--	34	9
RB251050	RBK2510	25	10	50	4	--	29	4
RB251056	RBSL2510	25	10	56	6	40	31	10
* RB251057	RBA2510	25	10	57	2	--	29	2
RB251060	RBST2510	25	10	60	6	--	31	7
RB251064	RBB2510	25	10	64	10	--	34	3
RB251075	RBL2510	25	10	75	10	--	34	9
* RB251150	RBK2511	25	11	50	4	--	29	4
RB251250	RBK2512	25	12	50	4	--	29	4
RB251256	RBSL2512	25	12	56	6	40	31	10
RB251257	RBA2512	25	12	57	2	--	29	2
RB251260	RBST2512	25	12	60	6	--	31	7
RB251264	RBB2512	25	12	64	10	--	34	3
RB251275	RBL2512	25	12	75	10	--	34	3
RB251375	RBL2513	25	1/2"	75	10	--	34	3
RB251450	RBK2514	25	14	50	4	40	29	10
RB251456	RBSL2514	25	14	56	6	40	31	10
RB251465	RBST2514	25	14	65	10	47,5	31	20
RB251475	RBL2514	25	14	75	10	58	34	20
RB251650	RBK2516	25	16	50	4	40	29	10
RB251656	RBSL2516	25	16	56	6	40	31	10
RB251665	RBST2516	25	16	65	10	47,5	31	20
RB251675	RBL2516	25	16	75	10	58	34	20
RB251850	RBK2518	25	18	50	4	40	29	10
RB251856	RBSL2518	25	18	56	6	40	31	10
RB251865	RBST2518	25	18	65	10	47,5	31	20
RB251875	RBL2518	25	18	75	10	58	34	20
RB251950	RBK2519	25	3/4"	50	4	40	29	10
RB251975	RBL2519	25	3/4"	75	10	58	34	20
RB252050	RBK2520	25	20	50	4	40	29	10
RB252056	RBSL2520	25	20	56	6	40	31	10
RB252057	RBA2520	25	20	57	6	40	29	10
RB252067	U243.2520	25	20	67	12	48	31	20
RB252065	RBST2520	25	20	65	10	47,5	31	20
RB252075	RBL2520	25	20	75	10	58	34	20

* sellout article

Reduzierhülsen / Reduction Sleeves

Artikel-Nr. article-no.	alte Art.-Nr. old art.-no.	D	d	L	L _B	L ₁	B	Bild pic
RB260470	RBST2604	1"	4	70	5	--	32	5
RB260570	RBST2605	1"	5	70	5	--	32	5
RB260670IK	RBST2606	1"	6	70	8	--	32	21
RB260870	RBST2608	1"	8	70	8	--	32	15
RB260870IK		1"	8	70	8	--	32	21
RB261070	RBST2610	1"	10	70	8	--	32	15
RB261070IK		1"	10	70	8	--	32	21
RB261270	RBST2612	1"	12	70	8	--	32	15
RB261470.1	RBST2614	1"	14	70	8	--	32	15
* RB261470.2	RBST2614L	1"	14	70	5	55	32	10
RB261670	RBST2616	1"	16	70	8	52	32	19
RB261870	RBST2618	1"	18	70	8	50	32	19
RB261970	RBST2619	1"	3/4"	70	8	50	32	19
RB262070	RBST2620	1"	20	70	8	50	32	19
<hr/>								
RB320563	RBK3205	32	5	63	5	--	36	4
RB320575	RBL3205	32	5	75	10	--	39	9
RB320658	RBM3206	32	6	58	5	--	36	6
RB320663	RBK3206	32	6	63	5	--	36	4
RB320670	RBST3206	32	6	70	10	--	39	18
RB320675	RBL3206	32	6	75	10	--	39	9
RB320858	RBM3208	32	8	58	5	--	36	6
RB320863	RBK3208	32	8	63	5	--	36	4
* RB320868	RBSL3208	32	8	68	6	50	38	10
RB320870	RBST3208	32	8	70	10	--	39	17
RB320875	RBL3208	32	8	75	10	--	39	9
RB321045	RBKK3210	32	10	45	5	25	39	10
RB321058	RBM3210	32	10	58	5	--	36	6
RB321063	RBK3210	32	10	63	5	--	36	4
RB321068	RBSL3210	32	10	68	6	50	38	10
RB321070	RBST3210	32	10	70	10	--	39	17
RB321075	RBL3210	32	10	75	10	--	39	9
RB321245	RBKK3212	32	12	45	5	25	39	10
RB321258	RBM3212	32	12	58	5	--	36	6
RB321263	RBK3212	32	12	63	5	--	36	4
RB321268	RBSL3212	32	12	68	6	50	38	10
RB321270	RBST3212	32	12	70	10	--	39	17
RB321275	RBL3212	32	12	75	10	--	39	3
RB321458	RBM3214	32	14	58	5	--	36	6
RB321463	RBK3214	32	14	63	5	--	36	4
RB321468	RBSL3214	32	14	68	6	50	38	10
RB321470	RBST3214	32	14	70	10	--	39	17
RB321475	RBL3214	32	14	75	10	--	39	3
RB321645	RBKK3216	32	16	45	5	25	39	10
RB321658	RBM3216	32	16	58	5	46	36	10
RB321663	RBK3216	32	16	63	5	47	36	10
RB321668	RBSL3216	32	16	68	6	50	38	10
RB321670	RBST3216	32	16	70	10	--	39	16
RB321675	RBL3216	32	16	75	10	--	39	3
RB321858	RBM3218	32	18	58	5	46	36	10
RB321863	RBK3218	32	18	63	5	47	36	10
RB321868	RBSL3218	32	18	68	6	50	38	10
RB321870	RBST3218	32	18	70	10	--	39	16
RB321875	RBL3218	32	18	75	10	58	39	20
RB321963	RBK3219	32	3/4"	63	5	47	36	10

* Ausverkaufsartikel

Artikel-Nr. article-no.	alte Art.-Nr. old art.-no.	D	d	L	L _B	L ₁	B	Bild pic
RB321975	RBL3219	32	3/4"	75	10	58	39	20
RB322045	RBKK3220	32	20	45	5	25	39	10
RB322058	RBM3220	32	20	58	5	46	36	10
RB322063	RBK3220	32	20	63	5	47	36	10
RB322068	RBSL3220	32	20	68	6	50	38	10
RB322070	RBST3220	32	20	70	10	--	39	17
RB322075	RBL3220	32	20	75	10	58	39	20
RB322258	RBM3222	32	22	58	5	46	36	10
RB322263	RBK3222	32	22	63	5	47	36	10
RB322270	RBST3222	32	22	70	10	49	39	19
RB322275	RBL3222	32	22	75	10	58	39	20
RB322545	RBKK3225	32	25	45	5	25	39	10
* RB322547	RBSM3225	32	25	47	7	32	38	10
RB322558	RBM3225	32	25	58	5	46	36	10
RB322563	RBK3225	32	25	63	5	47	36	10
RB322568	RBSL3225	32	25	68	6	50	38	10
RB322570	RBST3225	32	25	70	10	50	39	19
RB322575	RBL3225	32	25	75	10	58	39	20
RB322658	RBM3226	32	1"	58	5	47	36	10
RB322663		32	1"	63	5	47	36	10
RB322668	RBSL3226	32	1"	68	6	50	38	10
RB322675	RBL3226	32	1"	75	10	58	39	20
<hr/>								
RB400675	RBL4006	40	6	75	10	--	49	9
RB400695	RBST4006	40	6	95	12	--	49	17
RB400858	RBK4008	40	8	58	5	--	44	4
RB400875	RBL4008	40	8	75	10	--	49	9
RB400890	RBST4008	40	8	90	12	--	49	11
* RB400894	RBST4008L	40	8	94	12	--	49	17
RB401058	RBK4010	40	10	58	5	--	44	4
RB401075	RBL4010	40	10	75	10	--	49	9
RB401090	RBST4010	40	10	90	12	--	49	11
* RB401094.1	RBST4010	40	10	94	12	--	49	17
* RB401094.2	RBST4010	40	10	94	12	--	50	18
RB401258	RBK4012	40	12	58	5	--	44	4
RB401275	RBL4012	40	12	75	10	--	49	3
RB401290	RBST4012	40	12	90	12	--	49	11
RB401475	RBL4014	40	14	75	10	--	49	3
RB401490	RBST4014	40	14	90	12	--	49	11
RB401658	RBK4016	40	16	58	5	45	44	10
RB401668	RBC4016	40	16	68	5	46	50	10
RB401675	RBL4016	40	16	75	10	--	49	3
RB401690	RBST4016	40	16	90	12	--	49	11
RB401858	RBK4018	40	18	58	5	45	44	10
RB401868	RBC4018	40	18	68	5	46	50	10
RB401875	RBL4018	40	18	75	10	--	49	3
RB401890	RBST4018	40	18	90	12	--	49	11
RB402058	RBK4020	40	20	58	5	45	44	10
RB402068	RBC4020	40	20	68	5	46	50	10
RB402075	RBL4020	40	20	75	10	--	49	3
RB402094	RBST4020	40	20	94	12	--	49	16
RB402558	RBK4025	40	25	58	5	45	44	10
RB402568	RBC4025	40	25	68	5	46	50	10
RB402575	RBL4025	40	25	75	10	57	49	20

* sellout article

Artikel-Nr. article-no.	alte Art.-Nr. old art.-no.	D	d	L	L _B	L ₁	B	Bild pic
RB402594	RBST4025	40	25	94	12	72	49	19
RB403075	RBL4030	40	30	75	10	57	49	20
RB403258	RBK4032	40	32	58	5	45	44	10
RB403275	RBL4032	40	32	75	10	57	49	20
RB403294	RBST4032	40	32	94	12	72	49	19
RB500893	RBL5008	50	8	92,5	10	--	59	9
RB501093	RBL5010	50	10	92,5	10	--	59	9
RB501280	RBK5012	50	12	80	5	--	54	4
RB501293	RBL5012	50	12	92,5	10	--	59	3
RB501680	RBK5016	50	16	80	5	61	54	10
RB501693	RBL5016	50	16	92,5	10	--	59	3
RB502080	RBK5020	50	20	80	5	61	54	10
RB502093	RBL5020	50	20	92,5	10	--	59	3
RB502580	RBK5025	50	25	80	5	61	54	10
RB502593	RBL5025	50	25	92,5	10	--	59	3
RB503093	RBL5030	50	30	92,5	10	55	59	20
RB503280	RBK5032	50	32	80	5	61	54	10
* RB503293	RBL5032	50	32	92,5	10	55	59	20
RB504080	RBK5040	50	40	80	5	61	54	10
RB504093	RBL5040	50	40	92,5	10	55	59	20

* Ausverkaufsartikel

* sellout article

Reduzierhülsen mit Bund für INDEX

Reduction Sleeves with Flange for INDEX

Artikel-Nr. article-no.	d	Baugleich mit INDEX: identical with INDEX:
* RB220.4006	6	W64 220.4106
* RB220.4008	8	W64 220.4108
* RB220.4010	10	W64 220.4110
* RB220.4012	12	W64 220.4112
* RB220.4015	15	W64 220.4115

* Ausverkaufsartikel

* sellout article

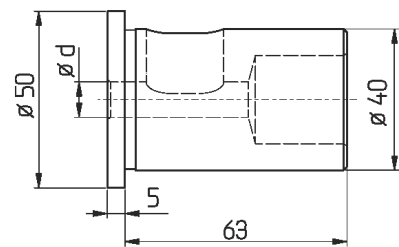

Reduzierhülsen mit Bund für MÜGA-Maschinen

Artikel-Nr. article-no.	d
RBST2010MU	10
RBST2012MU	12
RBST2014MU	14
RBST2016MU	16

Reduction Sleeves with Flange for MÜGA-Machines

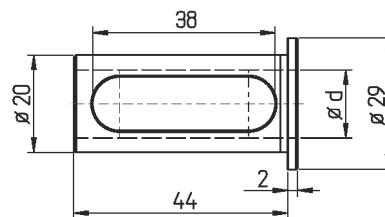

Reduzierhülsen für CITIZEN-Maschinen

Artikel-Nr. article-no.	D	Bild picture
RB201245CIT	20	1
RB262040CIT	1"	2
RB262048CIT	1"	3
U246.2520.050CIT	25	4
U246.2620.050CIT	1"	4

Reduction Sleeves for CITIZEN-Machines



Bild 1

Bild 2

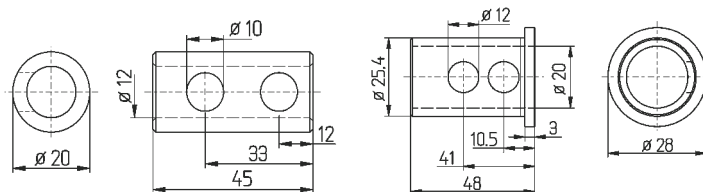

Bild 3

Bild 4

Reduzierhülsen mit Bund für MAZAK Maschinen

Reduction Sleeves with Flange for MAZAK machines

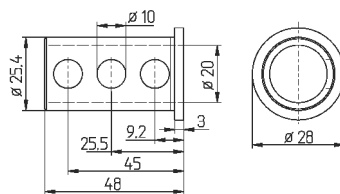
Artikel-Nr. article-no.	d
RBMZ2505	5
RBMZ2506	6
RBMZ2508	8
RBMZ2510	10
RBMZ2512	12
RBMZ2514	14
RBMZ2516	16
RBMZ2518	18
RBMZ2520	20

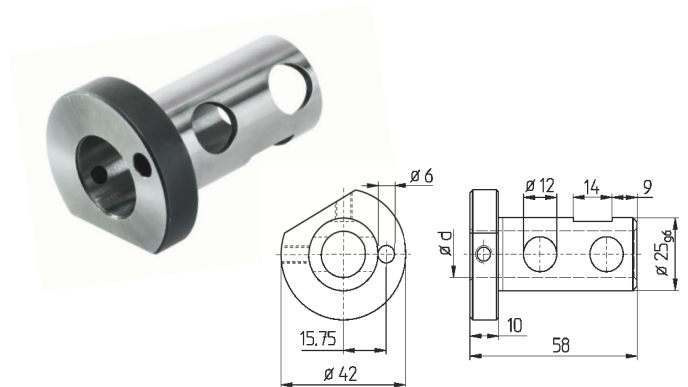

Reduzierhülsen

Reduction Sleeves

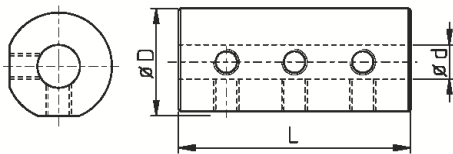

Typ 246

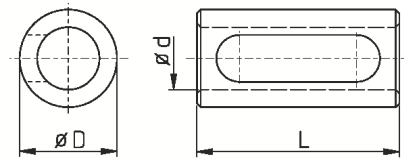

Typ 247

Artikel-Nr. article-no.	D	d	L
U246.2506 050	25	6	50
U246.2508 050	25	8	50
U246.2510 050	25	10	50
U246.2512 050	25	12	50
U246.2514 050	25	14	50
U246.2516 050	25	16	50
U246.2520 050	25	20	50

Artikel-Nr. article-no.	D	d	L
* U247.2508 050	25	8	50
* U247.2510 050	25	10	50
* U247.2512 050	25	12	50
* U247.2514 050	25	14	50
* U247.2516 050	25	16	50
* U247.2518 050	25	18	50
* U247.2520 050	25	20	50

* U247.3208 060	32	8	60
* U247.3210 060	32	10	60
* U247.3212 060	32	12	60
* U247.3214 060	32	14	60
* U247.3216 060	32	16	60
* U247.3218 060	32	18	60
* U247.3220 060	32	20	60
* U247.3225 060	32	25	60

* Ausverkaufsartikel

* *sellout article*

Reduzierhülsen, geschlitzt

Reduction Sleeves, Slotted

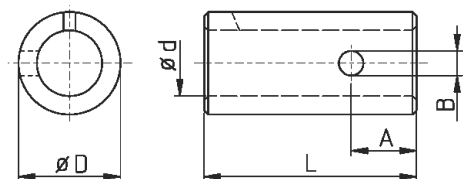

Gehärtet und geschliffen

Hardened and ground

Artikel-Nr. article-no.	Maschine machine	Orig. Ersatzteil-Nr. orig. spare part no.	A	L	D	B	d
* U290.50.30	INDEX B42-60-60F/8L C29	W35 200.1905	--	46	1"	--	3/4"
U290.60.40	INDEX B42-60-60F/6L	B35 752	20	46	1 1/4"	--	1"
* U242.115			--	46	3/4"	--	5/8"
* U242.116			--	46	3/4"	--	16,0
* U242.1614			--	25	16	--	14
* U242.2210	STAR / TRAUB TNL		--	50	22	--	10
* U242.2212	STAR / TRAUB TNL		--	50	22	--	12
U242.2216	STAR / TRAUB TNL		--	50	22	--	16
U242.2219	STAR / TRAUB TNL		--	50	22	--	3/4"
U242.2220	STAR / TRAUB TNL		--	50	22	--	20
* U242.319			--	46	25	--	3/4"
* U242.320			--	46	25	--	20
U242.322			--	46	25	--	22
* U242.415			--	46	1"	--	5/8"
U242.416			--	46	1"	--	16
U242.420			--	46	1"	--	20
U242.422			--	46	1"	--	22
* U242.2619			--	59	1"	--	19
* U242.2816	TRAUB TNL		12	46	28	2 x 8,5	16
* U242.2819	TRAUB TNL		12	46	28	2 x 8,5	3/4"
* U242.2820	TRAUB TNL		12	46	28	2 x 8,5	20
* U242.2822	TRAUB TNL		12	46	28	2 x 8,5	22
* U242.2825	TRAUB TNL		12	46	28	2 x 8,5	25
U242.522			--	46	30,0	--	22
U242.525			--	46	30,0	--	25
* U242.712			--	46	32	--	12
* U242.716			--	46	32	--	16
* U242.719			--	46	32	--	3/4"
* U242.720			--	46	32	--	20
* U242.722			--	46	32	--	22
* U242.725			--	46	32	--	25
* U242.726			--	46	32	--	1"

* Ausverkaufsartikel

* sellout article

Reduzierhülsen mit innerer Kühlmittelzufuhr Anschluss axial und radial

Reduction Sleeves with Inner Coolant Inlet Axial and Radial

Artikel-Nr. article-no.	D	d	L	L _B	AK / IK	B
RBIK1906 *	3/4"	6	65	14	2x G1/8"	24 *
RBIK1908	3/4"	8	65	14	2x G1/8"	24
RBIK1910	3/4"	10	65	14	2x G1/8"	24
RBIK1912	3/4"	12	65	14	2x G1/8"	24
RBIK1914	3/4"	14	65	14	2x G1/8"	24
RBIK1916	3/4"	16	65	14	2x G1/8"	24
RBIK2008	20	8	65	14	2x G1/8"	26
RBIK2010	20	10	65	14	2x G1/8"	26
RBIK2012	20	12	65	14	2x G1/8"	26
RBIK2016	20	16	65	14	2x G1/8"	26
RBIK2206 *	22	6	65	14	2x G1/8"	26 *
RBIK2208	22	8	65	14	2x G1/8"	26
RBIK2210	22	10	65	14	2x G1/8"	26
RBIK2212	22	12	65	14	2x G1/8"	26
RBIK2213	22	1/2"	65	14	2x G1/8"	26
RBIK2214	22	14	65	14	2x G1/8"	26
RBIK2216	22	16	65	14	2x G1/8"	26
RBIK2218	22	18	65	14	2x G1/8"	26
RBIK2508	25	8	70	19	2x G1/4"	29,5
RBIK2510	25	10	70	19	2x G1/4"	29,5
RBIK2512	25	12	70	19	2x G1/4"	29,5
RBIK2514	25	14	70	19	2x G1/4"	29,5
RBIK2516	25	16	70	19	2x G1/4"	29,5
RBIK2608	1"	8	70	19	2x G1/4"	29,5
RBIK2610	1"	10	70	19	2x G1/4"	29,5
RBIK2612	1"	12	70	19	2x G1/4"	29,5
RBIK2614	1"	14	70	19	2x G1/4"	29,5
RBIK2616	1"	16	70	19	2x G1/4"	29,5
RBIK3206K	32	6	55	3	G1/8"	40
RBIK3208K	32	8	55	3	G1/8"	40
RBIK3210K	32	10	55	3	G1/8"	40
RBIK3212K	32	12	55	3	G1/8"	40
RBIK3214K	32	14	55	3	G1/8"	40
RBIK3216K	32	16	55	3	G1/8"	40
RBIK3218K	32	18	55	3	G1/8"	40
RBIK3220K	32	20	55	3	G1/8"	40

Halter wird von
hinten eingesetzt
Reduction sleeve
inserted from back

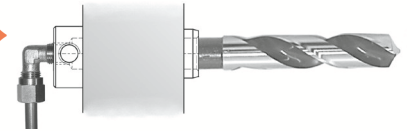

Kühlmittelanschluss auch radial möglich
Inner coolant inlet also possible radial

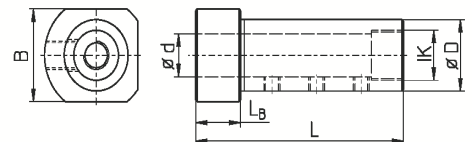
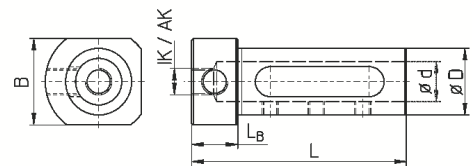

Anschluss axial (IK)
inner coolant inlet axial

* Mit Klemmfläche und 2 bzw. 3 Klemmschrauben
RBIK32...K Kühlmittelanschluss nur axial gegenüber Bundseite

* With clamping flat and 2 or 3 clamping screws
RBIK32...K inner coolant inlet only axial opposite to the flange

Reduzierhülsen für Morsekonus

Artikel-Nr. article-no.	D	MK	H	L	Bild picture
* V150.120	20	1	--	63	1
* V150.125	25	1	--	63	1
* V150.225	25	2	--	75	1
* V150.226	1"	2	--	75	2
* V150.230	30	2	--	71	2
* V150.132	32	1	--	63	2
* V150.240	40	2	--	95	2
<hr/>					
* RB10MK1	1"	1	--	90	3
* RB10MK2	1"	2	--	100	3
* RB16MK1	16	1	--	90	3
* RB20MK1	20	1	--	90	3
* RB20BMK1	20	1	--	76	3
* RB25MK1	25	1	--	95	3
* RB25MK2	25	2	--	95	3
* RB30MK1	30	1	--	76	3
* RB32MK1	32	1	--	90	3
* RB32MK2	32	2	--	100	3
* RB32MK3	32	3	--	120	3
* RB34MK1	3/4"	1	--	82	3
* RB34BMK1	3/4"	1	--	76	3

* Ausverkaufsartikel

* sellout article

Reduction Sleeves for Morse Taper

